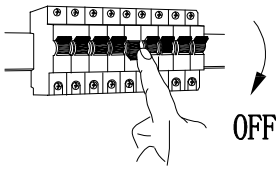
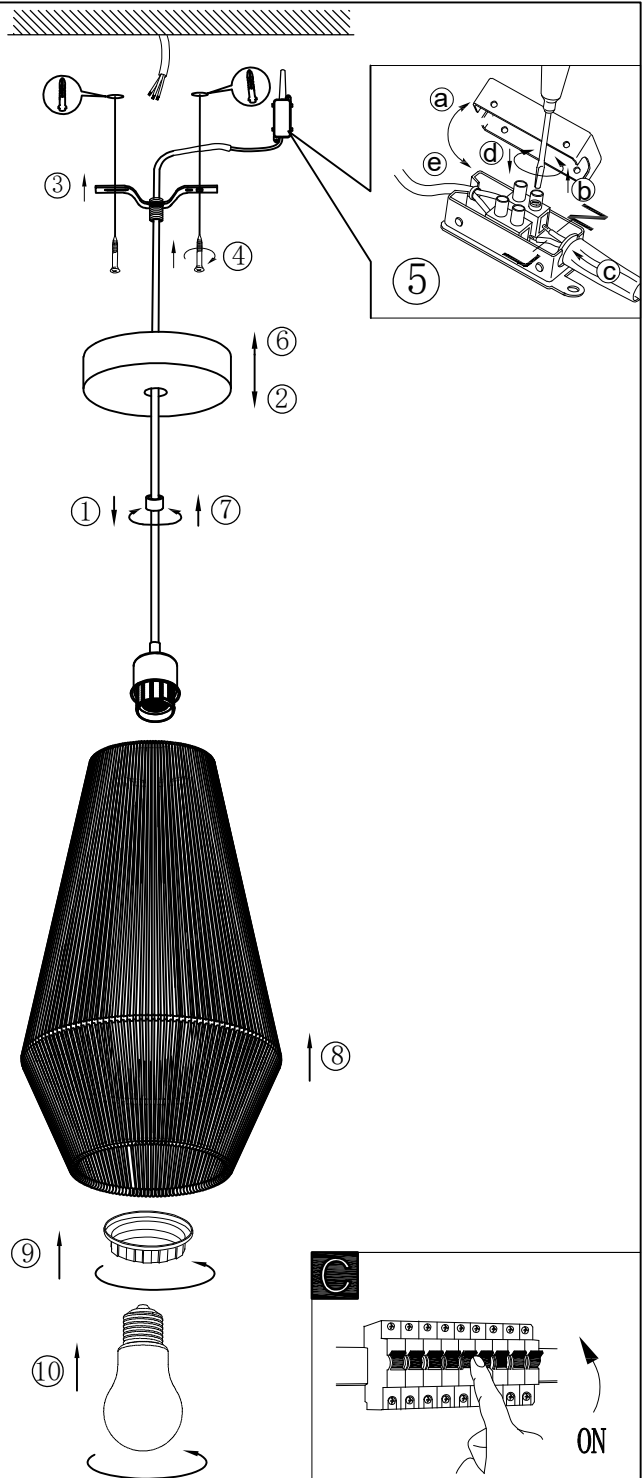
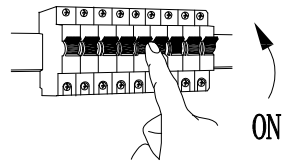

A**B****C**

B43785
www.eglo.com